

Installation instructions for PZ4AL-03521-00

Under Run Protective Shield Engine Bay and Transmission Case

TOYOTA COROLLA



Model year:

**Corolla
2018**

Applicability:

ZRE210L-DEFDKX
ZRE210L-DEXDKX
ZRE210L-DEXNKX
ZRE210L-DEXGKX

Part Number:

Steel: PZ4AL-03521-00



Weight:

Steel: 9,57 kg



Installation Time:

30 min

Rev.1 26.02.2019

PZ4AL-03521-00

A

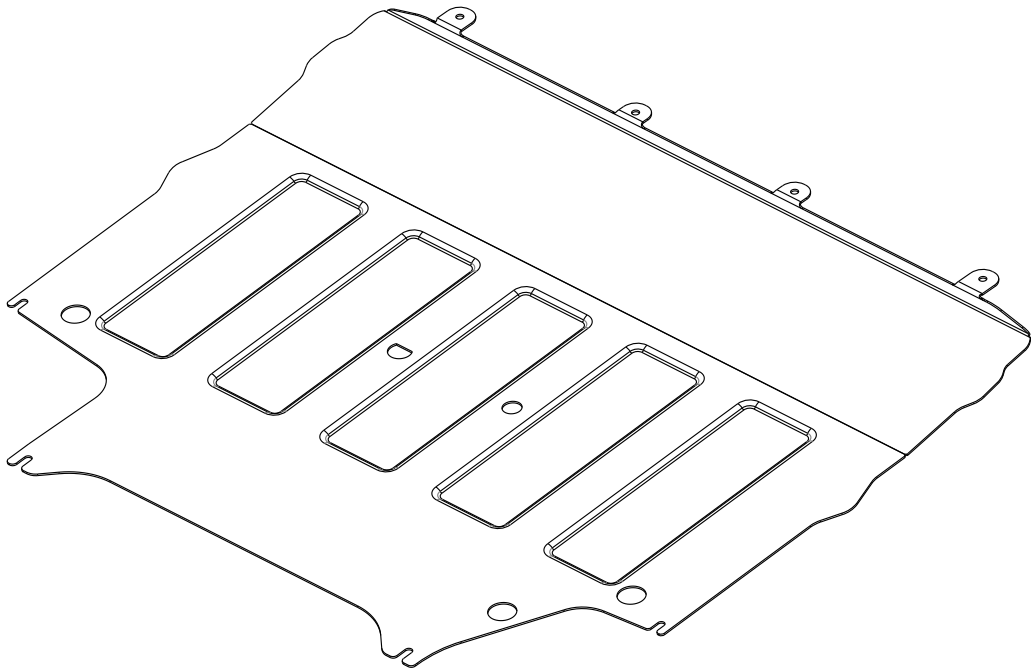

PZ4AL-03521-60

B

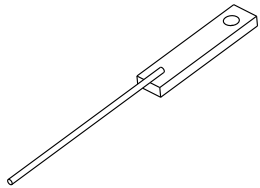

2x

C

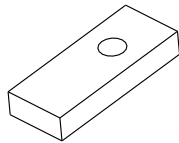

2x

D1

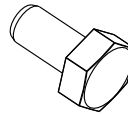

M6x20

6x

D2

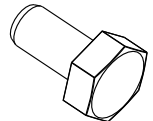

M8x20

2x

E1

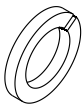

d=6

6x

E2



d=8

2x

F1

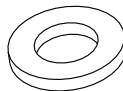

d=6

6x

F2

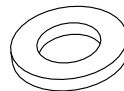

d=8

2x

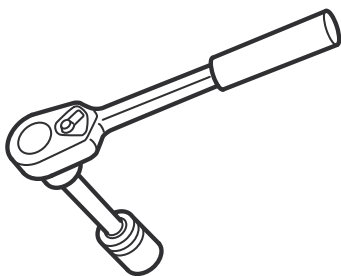

10 mm
13 mm



1

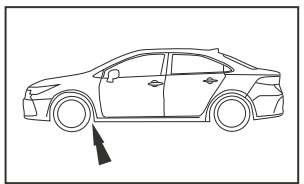
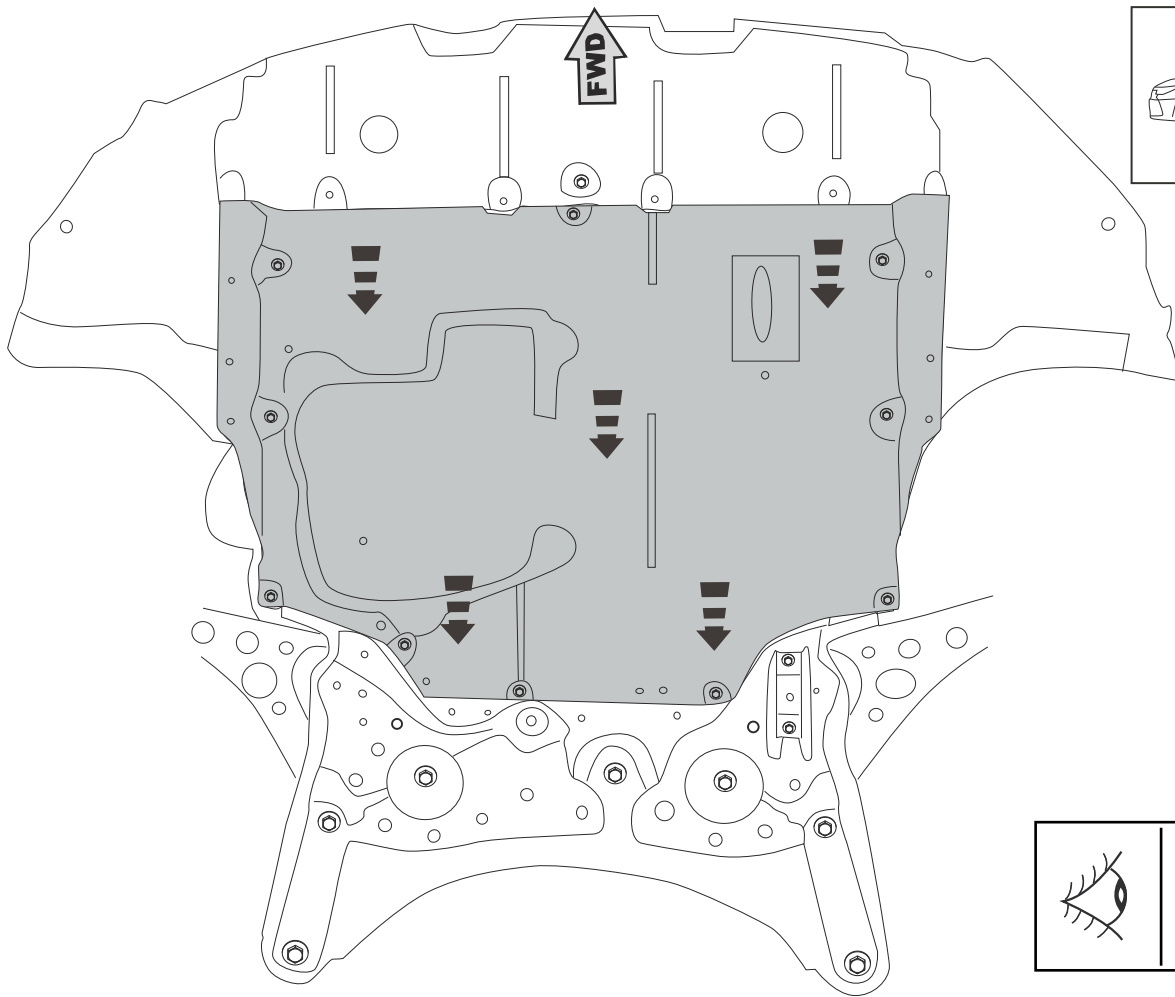

see repair manual

2

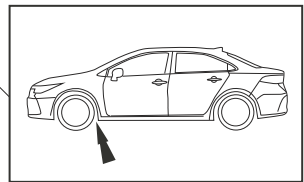
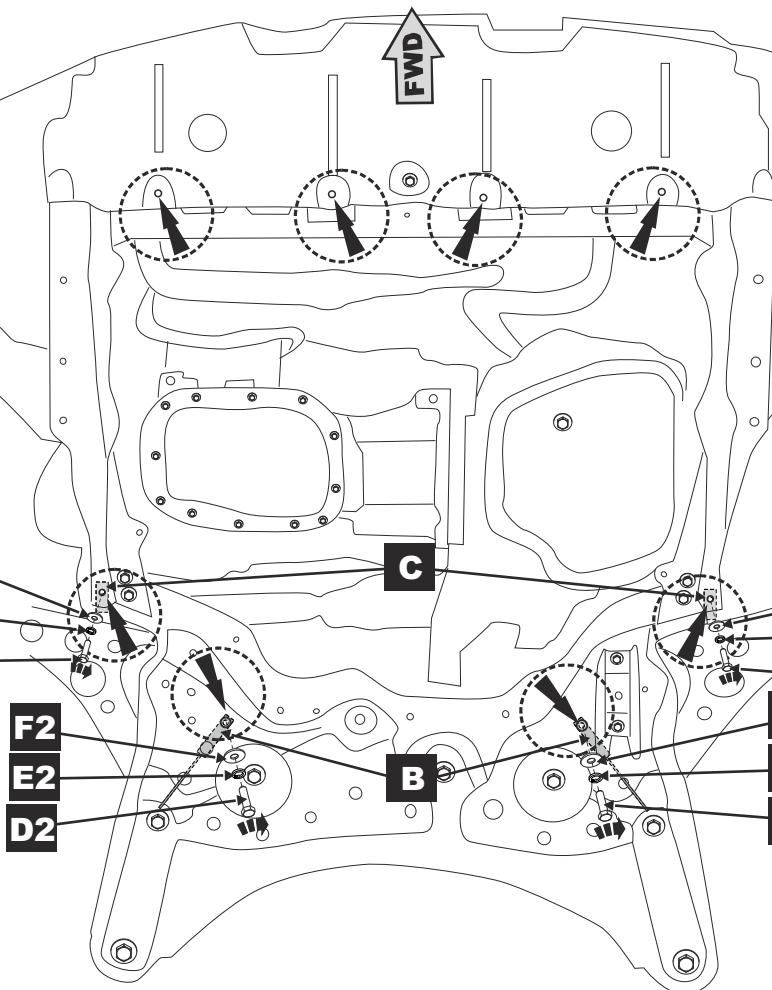

3

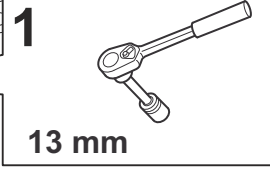
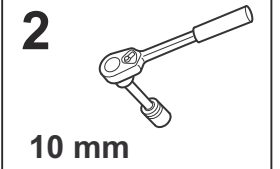
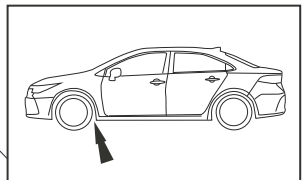
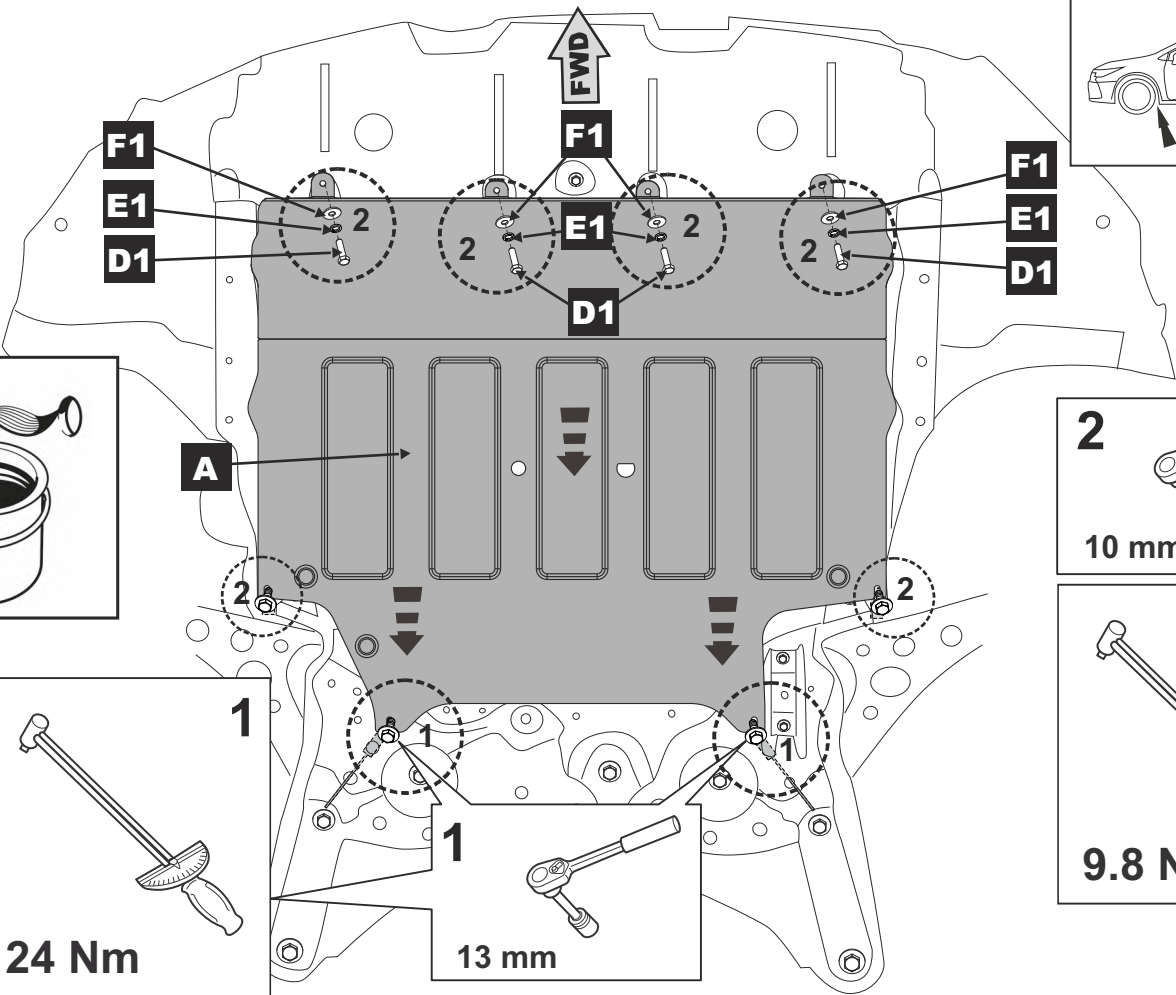

4

